



**SOUND BAR MODEL: SB0880**



# Instruction Manual

PLEASE READ BEFORE OPERATING THIS EQUIPMENT.

# Important Safety Instructions

- Read these Instructions.
- Keep these Instructions.
- Heed all Warnings.
- Follow all instructions.
- Do not use this apparatus near water.
- Clean only with a dry cloth.
- Do not block any ventilation openings. Install in accordance with the manufacturer's instructions.
- Do not install near any heat sources such as radiators, heat registers, stoves, or other apparatus (including amplifiers) that produce heat.
- Do not defeat the safety purpose of the polarized or grounding - type plug. A polarized plug has two blades with one wider than the other. A grounding type plug has two blades and a third grounding prong. The wide blade or the third prong is provided for your safety. When the provided plug does not fit into your outlet, consult an electrician for replacement of the obsolete outlet.
- Protect the power cord from being walked on or pinched particularly at plugs, convenience receptacles, and the point where they exit from the apparatus.
- Only use attachments/accessories specified by the manufacturer.
- This symbol indicates that this product incorporates double insulation between hazardous mains voltage and user accessible parts. Use only with a cart, stand, tripod, bracket, or table specified by the manufacturer, or sold with the apparatus. When a cart is used, use caution when moving the cart/apparatus combination to avoid injury from tip-over.



- Unplug this apparatus during lightning storms or when unused for long periods of time.
- Refer all servicing to qualified service personnel. Servicing is required when the apparatus has been damaged in any way, such as power-supply cord or plug is damaged, liquid has been spilled or objects have fallen into the apparatus, the apparatus has been exposed to rain or moisture, does not operate normally, or has been dropped.

**Special note:** When placing your unit on a lacquered or natural finish, protect your furniture with a cloth or other protective material.

## FCC AND IC STATEMENT FOR USERS

This device complies with part 15 of the FCC Rules. Operation is subject to the following two conditions: (1) This device may not cause harmful interference, and (2) this device must accept any interference received, including interference that may cause undesired operation.

### Federal Communication Commission Interference Statement

This equipment has been tested and found to comply with the limits for a Class B digital device, pursuant to Part 15 of the FCC Rules. These limits are designed to provide reasonable protection against harmful interference in a residential installation. This equipment generates, uses and can radiate radio frequency energy and, if not installed and used in accordance with the instructions, may cause harmful interference to radio communications. However, there is no guarantee that interference will not occur in a particular installation. If this equipment does cause harmful interference to radio or television reception, which can be determined by turning the equipment off and on, the user is encouraged to try to correct the interference by one or more of the following measures:

- Reorient or relocate the receiving antenna.
- Increase the separation between the equipment and receiver.
- Connect the equipment into an outlet on a circuit different from that to which the receiver is connected.
- Consult the dealer or an experienced radio/TV technician for help.



This symbol indicates that this product incorporates double insulation between hazardous mains voltage and user accessible parts.

# Warnings and Precautions

**CAUTION:** TO PREVENT ELECTRIC SHOCK, MATCH WIDE BLADE OF PLUG TO WIDE SLOT, FULLY INSERT.

**WARNING:** To reduce the risk of fire or electric shock, do not expose this apparatus to rain or moisture. When the mains plug or an appliance coupler is used as the disconnect device, the disconnect device shall remain readily operable.

**CAUTION:** These servicing instructions are for use by qualified service personnel only. To reduce the risk of electric shock, do not perform any servicing other than that contained in the operating instructions unless you are qualified to do so.

**WARNING:** Changes or modifications to this unit not expressly approved by the party responsible for compliance could void the user's authority to operate the equipment.

**WARNING:** Do not install this equipment in a confined or building-in space such as a book case or similar unit, and remain a well ventilation conditions at open site. The ventilation should not be impeded by covering the ventilation openings with items such as newspaper, table-cloths, curtains etc.

**WARNING:** Use of this unit near fluorescent lighting may cause interference regarding use of the remote. If the unit is displaying erratic behavior move away from any fluorescent lighting, as it may be the cause.

**CAUTION:** Only use attachments/accessories specified or provided by the manufacturer (such as the exclusive supply adapter, battery etc).

**WARNING:** The battery, batteries, and battery pack shall not be exposed to excessive heat such as sunshine, fire, or the like.

**WARNING:** Lithium batteries, like all rechargeable batteries are recyclable and should be recycled or disposed of in normal household waste. Contact your local government for disposal or recycling practices in your area. They should never be incinerated since they might explode.

**WARNING:** Shock hazard - Do Not Open.

Mains Plug or Direct plug-in adapter is used as disconnect device and it should remain readily operable during intended use. In order to disconnect the apparatus from the mains completely, the Mains Plug or Direct plug-in adapter should be disconnected from the mains socket outlet completely.



**WARNING:** To reduce the risk of fire or electric shock, do not expose this product to smoke, rain, dust or moisture!



The lightning flash with arrow-head symbol, within an equilateral triangle, is intended to alert the user to the presence of non-insulated "dangerous voltage" within the product's enclosure that may be of sufficient magnitude to constitute a risk of electric shock to persons.



To reduce the risk of electric shock, do not remove cover (or back). No user-serviceable parts inside. Refer servicing to qualified service personnel.

**Thank you** for purchasing the excellent quality sound bar for your home. We recommend that you spend some time reading this instruction manual in order that you fully understand all the operational features it offers. You will also find some hints and tips to help you resolve any issues. Read all the safety instructions carefully before use and keep this instruction manual for future reference.

## Check the package contents

Remove all items from the packing. Retain the packaging. If you dispose of it please do so according to local regulations.

The following items are included:

1. A sound bar
2. A external subwoofer
3. Remote control
4. Mains adapter
5. OPTICAL cable
6. 3.5mm audio cable
7. Wall Bracket
8. Wall fixing & screws
9. Instruction manual

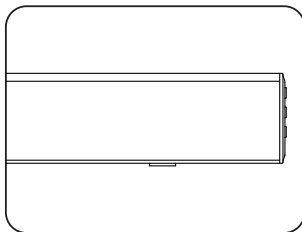

Sound bar product

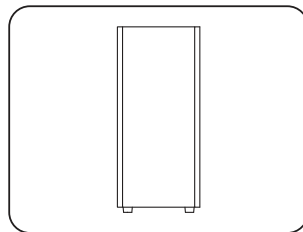

Subwoofer

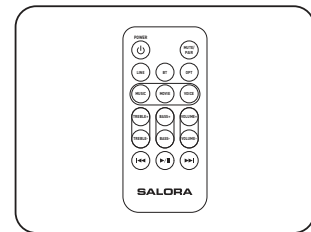

Remote control

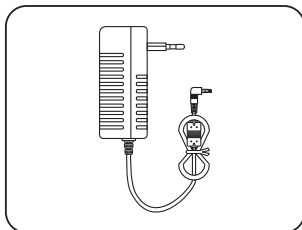

Mains power adapter

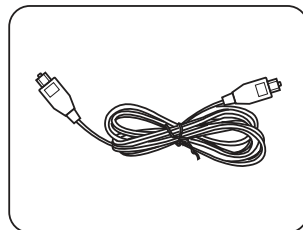

OPTICAL cable

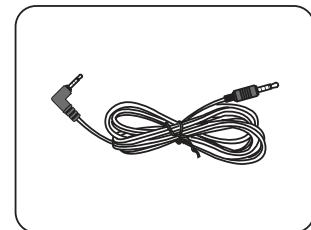

3.5mm audio cable

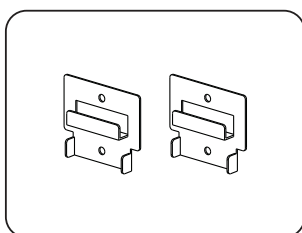

Wall Bracket

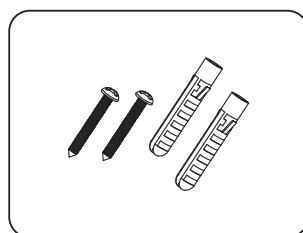

Wall fixing & screws

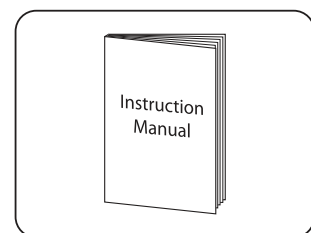

Instruction manual

# Product description

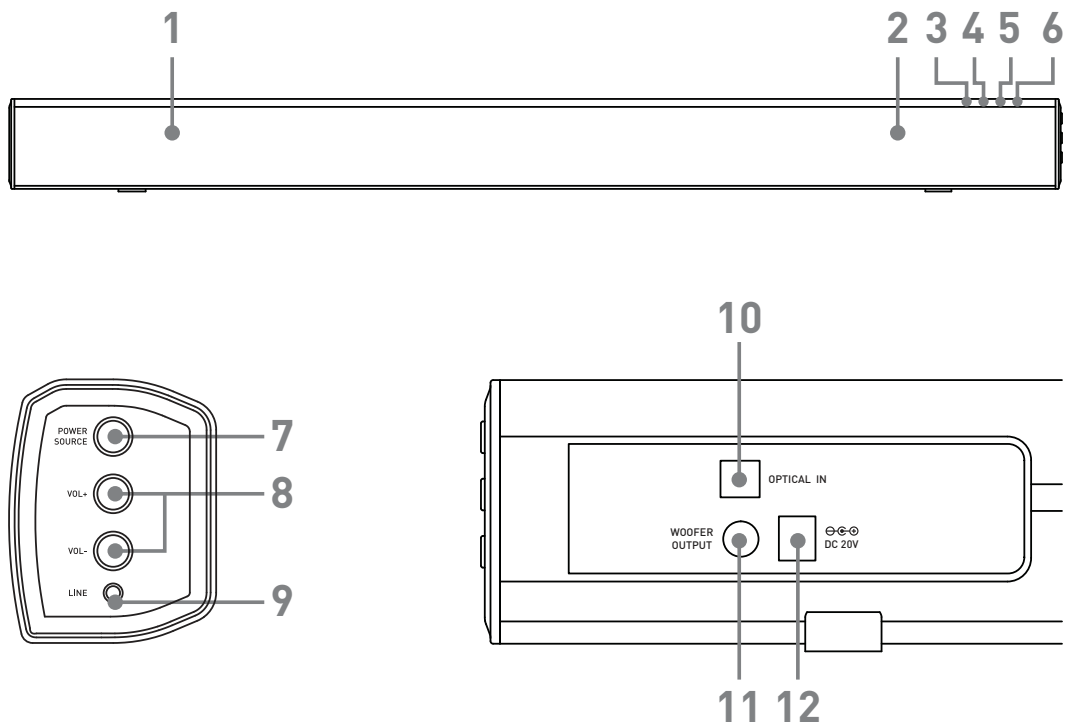

1. **SPEAKER**
2. **The Remote Control Sensor**
3. **BT** ---- Blue Light
4. **OPT** ---- White Light
5. **LINE** ---- Green Light
6. **⏻** ---- Red Light
7. **Power and Source button** ---- Press and hold 3 seconds to switch the unit on or off.  
One touch to select a input: BT, Line in or Optical in.
8. **Volume + and -** ---- Press to adjust the volume up or down.
9. **3.5mm Line In Socket**
10. **OPTICAL In Socket**
11. **Subwoofer Output**
12. **DC (20V 1.2A) Socket**

# Remote control

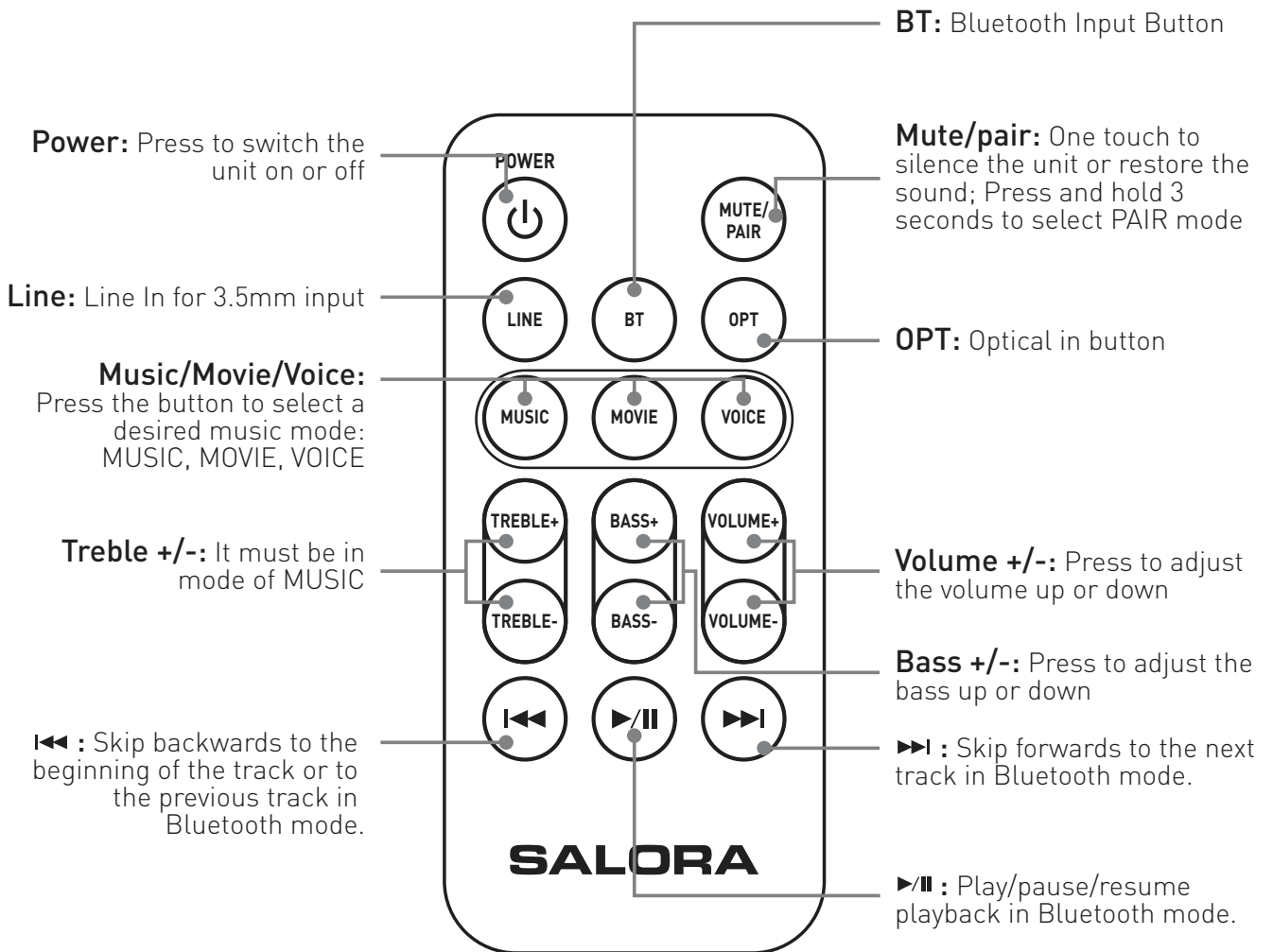

# Connections

Follow the below connection guide to connect the sound bar to a TV with or without a digital output, a Blu-ray/DVD player or an audio source such as an MP3 player.

Only one digital connection to a TV is required. Use the optical connection.

**DO NOT** power on the mains until all other connections are made.

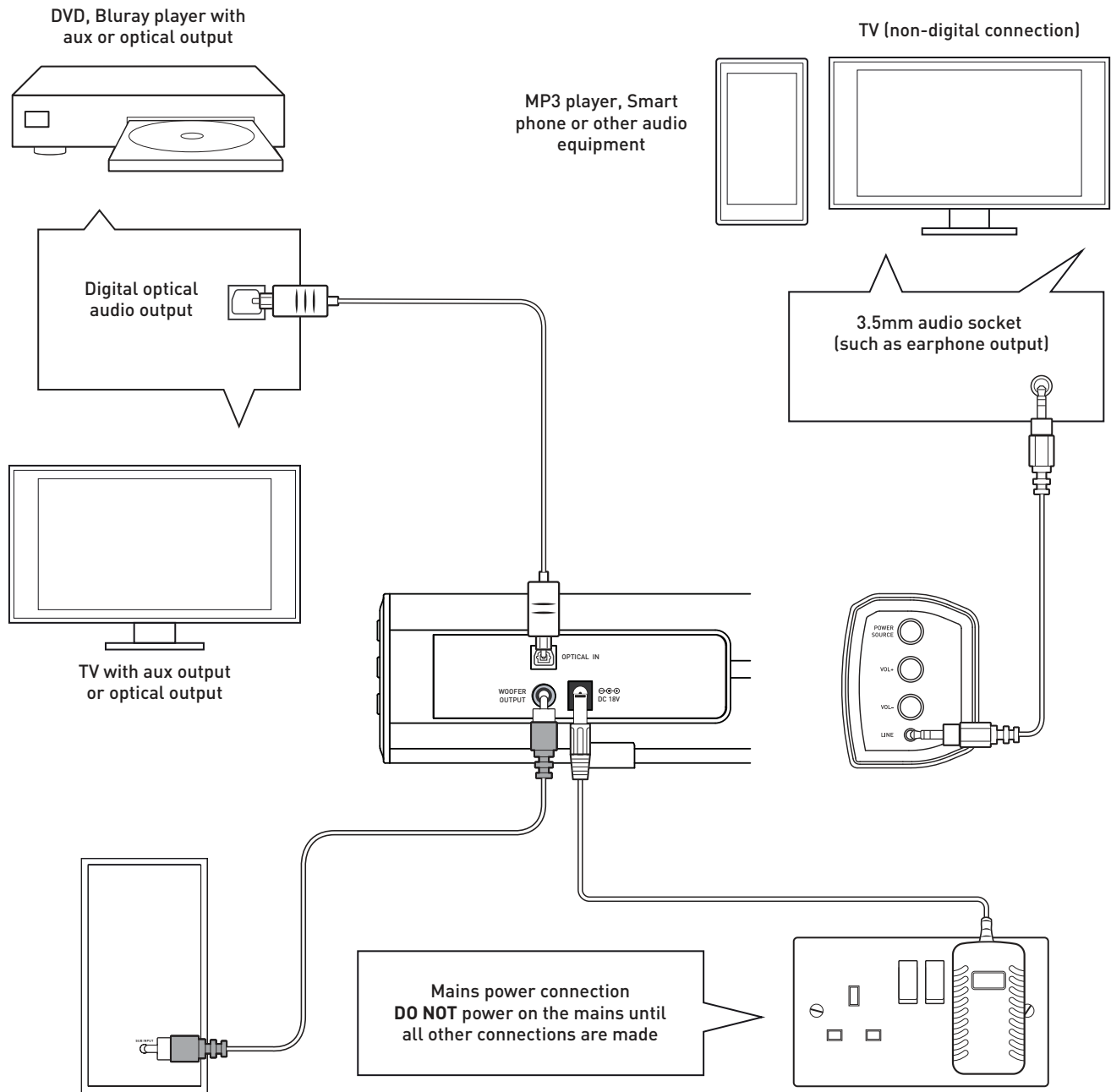

# Connections

## Using the optical input

You will need: An audio source with an optical Audio output and a digital optical audio cable (included)

1. Connect the digital optical audio cable to the optical output on the audio source and to the OPTICAL IN on the speaker bar.
2. Press and hold 3 seconds the POWER/SOURCE button on side panel or POWER button directly on the remote control to switch on the unit.
3. Press the SOURCE button on your remote control repeatedly to switch to optical mode or one touch the POWER/SOURCE button on main unit repeatedly to select the optical mode. The mode indicator LED will turn orange.
4. Using the native controls on your connected device, make sure the audio settings are set to PCM or optical audio and are turned on.
5. Audio from the connected audio source will now be played through the speakers.

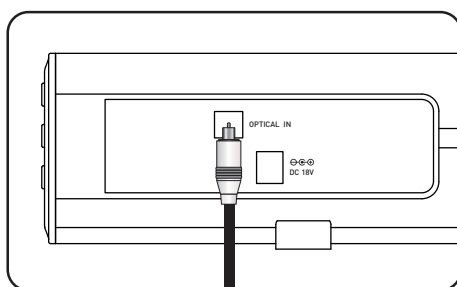

## Using the LINE IN

1. Plug one end of a 3.5mm audio input cable (included) into the LINE IN on the unit. Before use, disconnect and cables connected to the stereo RCA inputs.
2. Plug the other end of the cable into the audio output/headphone output on an MP3 player or other audio source.
3. Press and hold 3 seconds the POWER/SOURCE button on side panel or POWER button directly on the remote control to switch on the unit.
4. Press the SOURCE button on your remote control repeatedly to enter LINE IN mode or one touch the POWER/SOURCE button on the unit repeatedly to enter LINE IN mode. The mode indicator will turn green.
5. Audio played through the connected device will now be heard through the speakers.

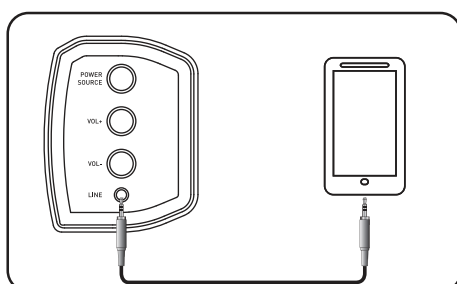



# Pairing a bluetooth device

---

Before you can use the sound bar with your phone or other bluetooth capable device you will need to pair the device to the sound bar.

Pairing a bluetooth device for the first time

1. Press and hold 3 seconds the POWER/SOURCE button on the unit or the POWER button on the remote control to switch on the unit.
2. Select and press the SOURCE button directly on the remote control to enter bluetooth mode or press the POWER/SOURCE button repeatedly to enter bluetooth mode, indicated by a blue light.
3. Press the PAIR button on the remote control or the unit directly. The pairing indicator will flash quickly. When pairing, remain within 3 feet of the unit.
4. Using the native controls on your bluetooth device, select the "SB0880" in your bluetooth settings to pair.
5. When successfully paired and connected, a beep will issue from the unit and the pairing indicator will display a solid blue light. After initial pairing, the unit will stay paired unless unpaired manually by the user, or until it is erased due to a reset of the device.

If your device should become unpaired or you find it is unable to connect, repeat the above steps.

1. The ►/|| button on the main unit (3) or on the remote when pressed will begin playback of the selected track on the audio device. Press again to pause playback.
2. To skip to the next track press the ►| button on the remote.
3. To skip to the next track press the |◀ button on the remote.
4. Any further operations must be done from the audio device.
5. Soundbar has bluetooth connected to a device, you can press MUTE/PAIR button 3 seconds to exit this device in order to pair the device with another bluetooth device. If your device should become unpaired or you find it is unable to connect, repeat the above steps.

---

The volume output is effected by the volume level on the audio source EG: Phone or laptop, so make sure that is set to about 70-80% (not too loud to avoid distortion).

---

## Bluetooth notes

- The operation range of bluetooth is approximately 10 meters (30 Feet). Any obstacles in the path between devices may reduce this range.
- Only one bluetooth device can be paired at a time.
- Not all bluetooth devices are compatible.

# Connecting to the Mains Supply

- Ensure that the power supply voltage is in the voltage of 100V~240V.
- This unit is designed to use adapter.
- Connecting the unit to any other power source may cause damage to the unit. Unwind the mains cable to its full length. Connect the mains plug to a mains socket. Make sure the mains plug is fully inserted into the mains socket.
- The mains plug/appliance coupler is used as the disconnect device, the disconnect device must remain readily operable.
- Connect the Adapter to the unit and AC Socket.

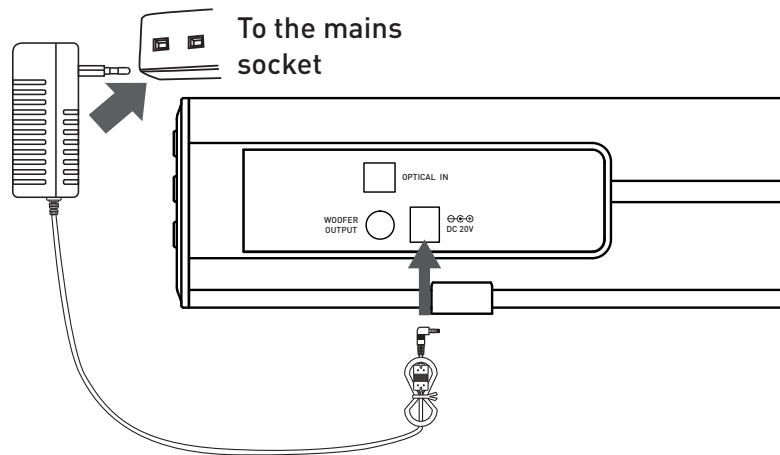

- Ensure all audio connections of the unit are connected before connecting to the mains power socket.
- Unplug the power cord from the outlet when the unit is use for an extended period of time.

# Specifications

Power Supply	DC 20V 1.2A
Speaker Output Power	15W*2+50W(woofer)
Frequency Respond	20Hz - 20KHz $\pm$ 3dB
SNR	$\geq$ 70dB
Separation	$\geq$ 45dB
Bluetooth	V3.0
Dimension(W) $\times$ (H) $\times$ (D)	Sound bar: 800 x 74 x 56mm Subwoofer: 188 x 350 x 188mm
Net Weight	Sound bar: 1.2kg Subwoofer: 3.2kg